

PROFILATI
Profiles

Persiane



Persiana UNIVERSAL

SEZIONE	CODICE	PESO gr/ml	DESCRIZIONE
	T 3323	526 g/ml	LAMELLA UNIVERSAL 55 CON RIGO
	T 3324	516 g/ml	LAMELLA UNIVERSAL 55 SENZA RIGO
	T 3325	912 g/ml	LAMELLA PARTNER
	T 370	392 g/ml	LAMELLA DI COMPENSAZIONE
	T 372	324 g/ml	POSIZIONATORE DA 25mm
	T 377	356 g/ml	POSIZIONATORE LISCIO
	T 373	392 g/ml	POSIZIONATORE

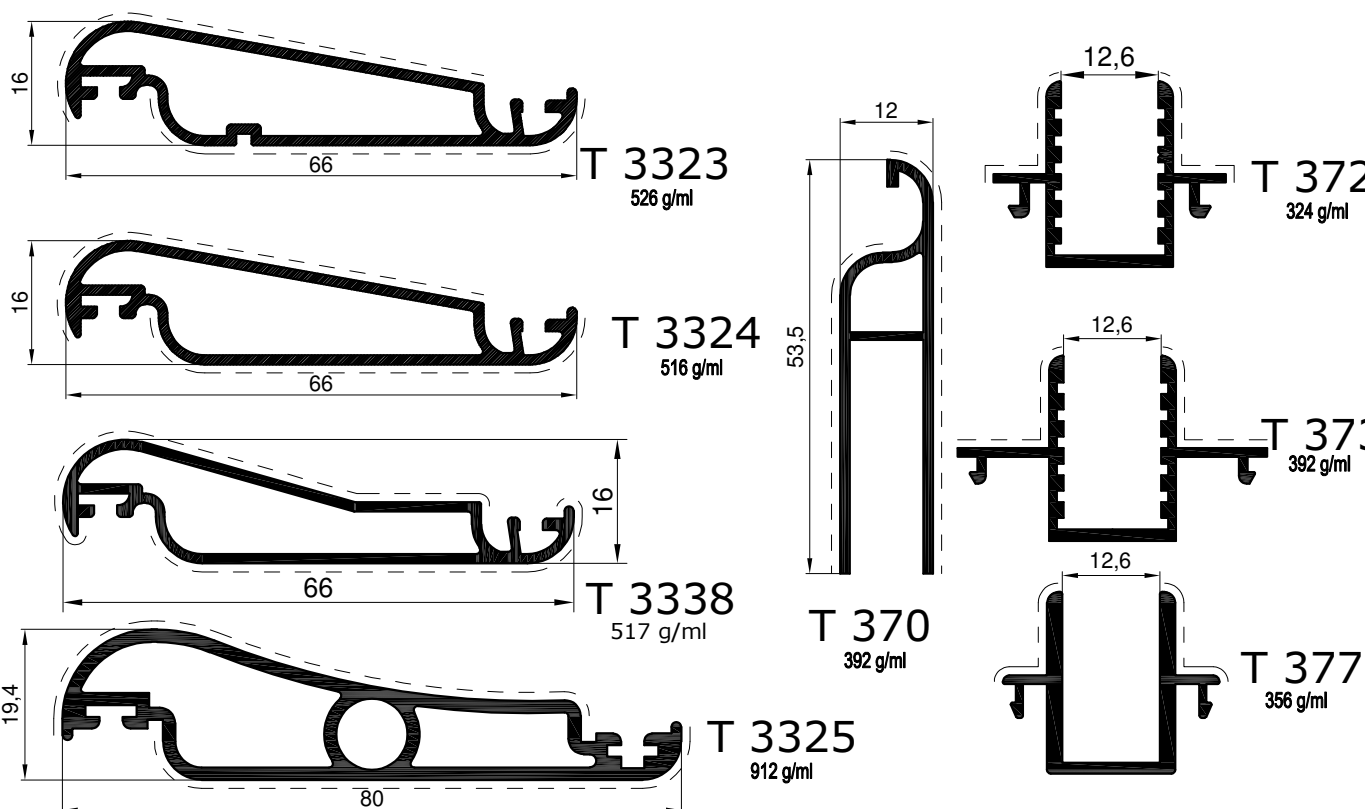

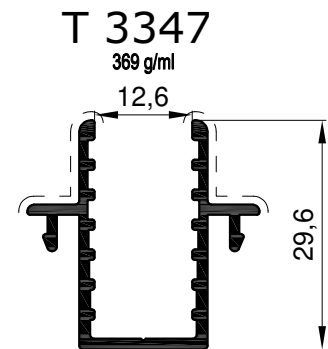
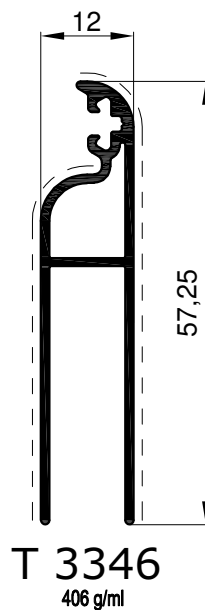
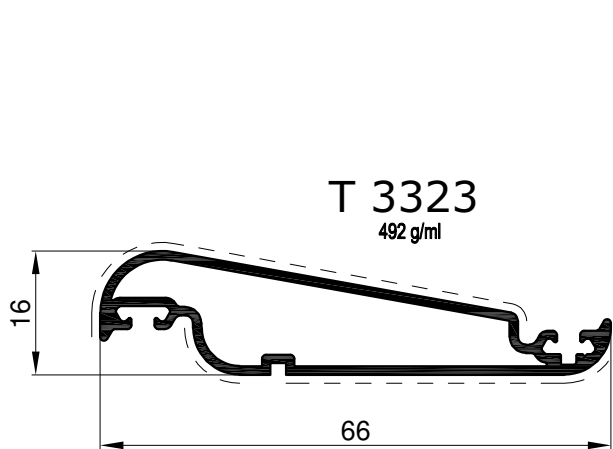

Persiana UNIVERSAL +

SEZIONE	CODICE	PESO gr/ml	DESCRIZIONE
	T 3345	492 g/ml	LAMELLA 66 CON RIGO
	T 3346	406 g/ml	LAMELLA DI COMPENSAZIONE
	T 3347	369 g/ml	POSIZIONATORE

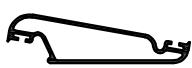

Persiana NACO

SEZIONE	CODICE	PESO gr/ml	DESCRIZIONE
	T 3328	531 g/ml	LAMELLA PE.R.LA. 70
	TO 3104	450 g/ml	LAMELLA SP54
	T 376	450 g/ml	LAMELLA DI COMPENSAZIONE PE.R.LA. 70

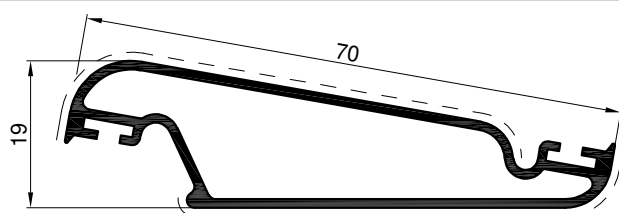

T 3328
531 g/ml

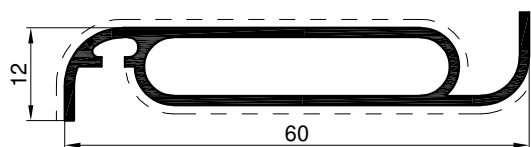

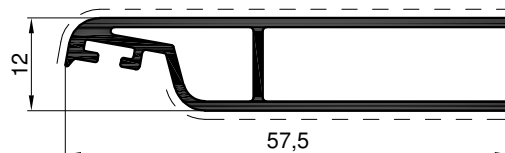

TO 3104
450 g/ml



T 376
450 g/ml

Persiana metaltecnica KOSMICA

SEZIONE	CODICE	PESO gr/ml	DESCRIZIONE
	T 3329	545 g/ml	LAMELLA OVALINA
	T 3326	550 g/ml	LAMELLA SEK

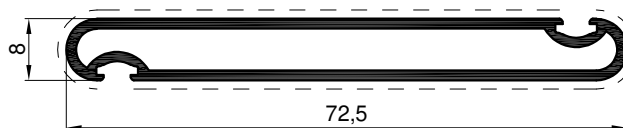

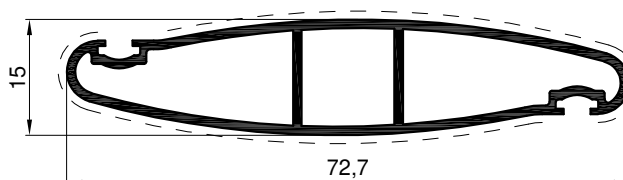

T 3329
545 g/ml



T 3326
550 g/ml

Persiana SOLARIA

SEZIONE	CODICE	PESO gr/ml	DESCRIZIONE
	T 3330	558 g/ml	LAMELLA SOLARIA
	T 378	268 g/ml	POSIZIONATORE
	T 379	410 g/ml	LAMELLA DI COMPENSAZIONE SOLARIA

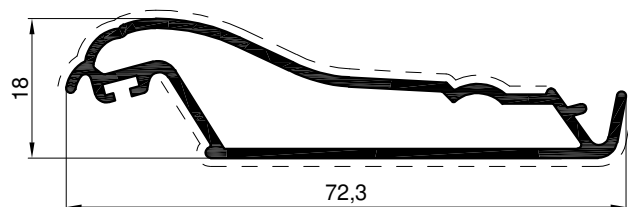

T 3330
558 g/ml

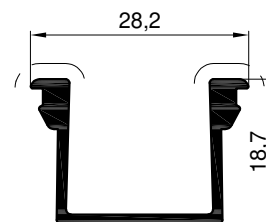

T 378
268 g/ml

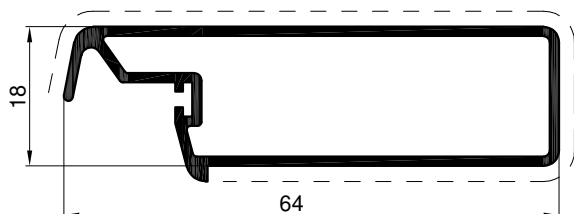

T 379
410 g/ml





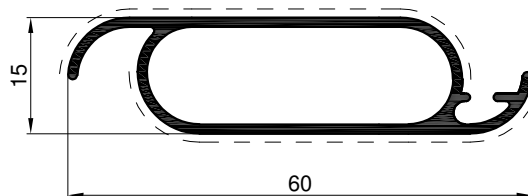

Persiana EQ40

SEZIONE	CODICE	PESO gr/ml	DESCRIZIONE
	T 3546	446 g/ml	LAMELLA EQ

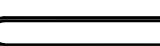

T 3546
446 g/ml

Persiana FISSA

SEZIONE	CODICE	PESO gr/ml	DESCRIZIONE
	T 9100	404 g/ml	LAMELLA DA 50 mm S=1,4 mm
	T 3333	348 g/ml	LAMELLA DA 50 mm S=1,2 mm
	T 3327	383 g/ml	LAMELLA DA 60 mm S=1,1 mm
	T 3332	445 g/ml	LAMELLA DA 65 mm S=1,2 mm
	T 3336	293 g/ml	LAMELLA DA 50 mm S=1 mm
	SC 1028	346,1 g/ml	LAMELLA DA 49,5 mm S = 1,2
	T 381	211 g/ml	POSIZIONATORE LAMELLA FISSA
	CL 5120	205 g/ml	LAMELLA DA 30 mm S = 1,2

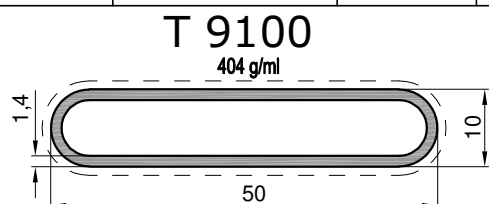

* SC 1028
346,1 g/ml

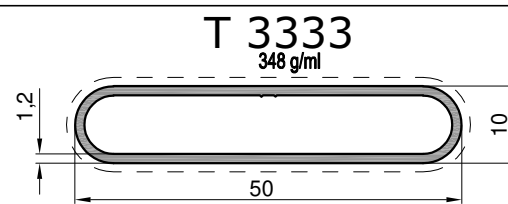
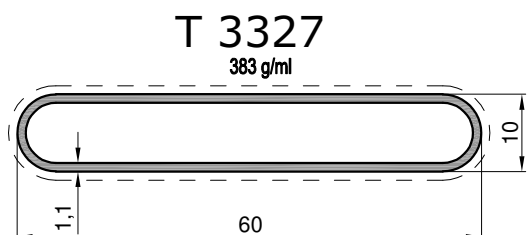
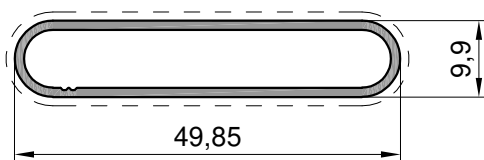



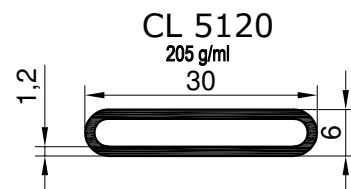
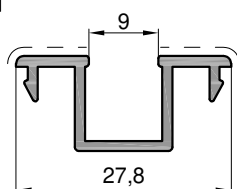
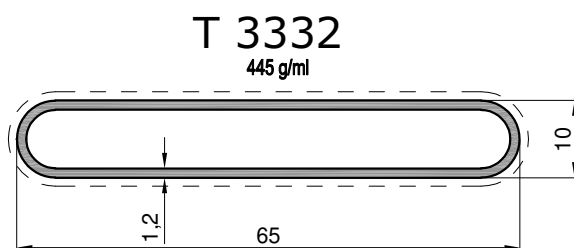
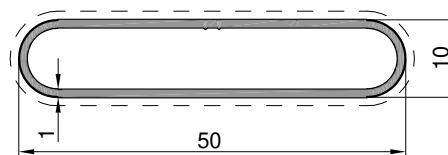

T 3336
293 g/ml



* MATRICE RISERVATA

Persiana

SEZIONE	CODICE	PESO gr/ml	DESCRIZIONE
	T 3334	478 g/ml	LAMELLA LUNA
	CL 5737	531 g/ml	LAMELLA LUNA RINFORZATA
	T 3335	486,5 g/ml	LAMELLA EURO ALLUMINIO
	T 382	445 g/ml	MEZZALAMELLA EUROALLUMINIO
	SC 1395	527 g/ml	LAMELLA SIALL SENZA RINFORZO
	SC 1923	463 g/ml	LAMELLA ISTRAL ALLUMINI

T 3334
478 g/ml

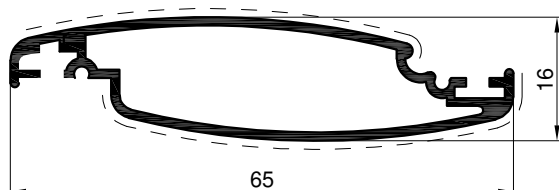

CL 5737
531 g/ml

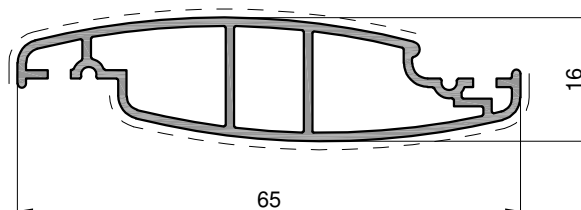

T 3335
486,5 g/ml

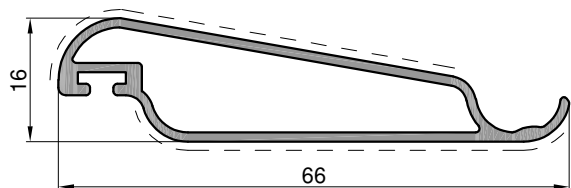

T 382
445 g/ml

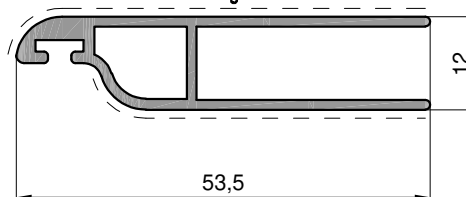

SC 1395
527 G/ML

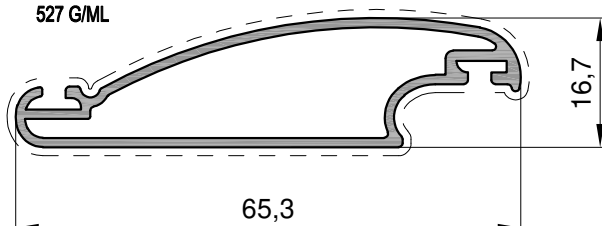

SC 1923
463 G/ML

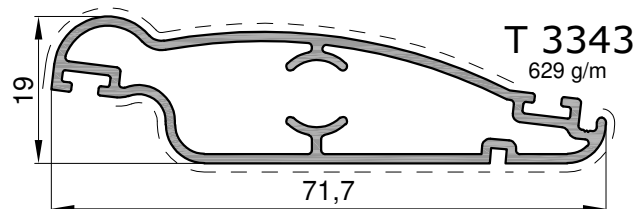
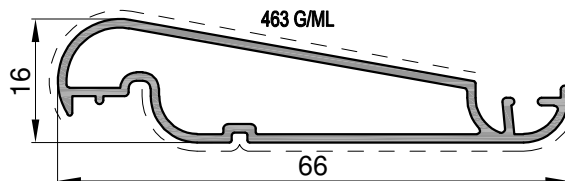

T 3343
629 g/m